

FEATURES

- » High performance product with low RC time constant
- » Long lifetimes with over 1,000,000 duty cycles
- » Rated capacitance of 1600F
- » Weldable terminals for easy integration
- » Compliant with RoHS and REACH requirements



* Image is not to scale

SPECIFICATIONS

Electrical		ESHSR-1600C0-002R7A5
Rated Voltage (V_R) at 65°C		2.7 VDC
Surge Voltage ¹		2.85 VDC
Rated Capacitance ²		1600 F
Capacitance Tolerance	Max.	-0% / +20%
	Avg. ⁴	+5% / +12%
DC-ESR, Initial ³	Max.	0.41 mΩ
	Avg. ⁴	0.16 mΩ
Max. Leakage Current ⁵		3.0 mA
Maximum Continuous Current	at $\Delta T = 15^\circ\text{C}$	100 A
	at $\Delta T = 40^\circ\text{C}$	164 A
Maximum Peak Current, Non-repetitive ⁶		1,300 A
Max. Stored Energy (E_{max}) at V_R ⁷		1.6 Wh
Usable Specific Power ⁷		6.3 kW/kg
Impedance Match Specific Power ⁷		13.2 kW/kg
Max. Gravimetric Specific Energy ⁷		4.8 Wh/kg

Temperature	
Operating Temperature Range	-40 ~ 65°C ($\Delta\text{CAP} < 5\%$ and $\Delta\text{ESR} < 100\%$ of initial value measured at 25°C)
Storage Temperature Range	-40 ~ 70°C (storage without charge)

Life	
Endurance (at V_R and 65°C) ^{8,9}	1,500 hours
Room Temperature (at V_R and 25°C) ⁸	10 years
Cycle Life (at 25°C) ⁸	1,000,000 cycles (Estimated value when cycled from V_R to $1/2V_R$ using constant current of 100A with 10 second rest between charge and discharge steps)
Shelf Life	2 years (Stored without charge at under 70°C and under 40% RH)

Safety & Certification	
RoHS	Compliant
REACH	Compliant
UL	Complies to 810A, Certificate No.: BBBG2.MH46340

THERMAL

Characteristics	ESHSR-1600C0-002R7A5
Typical Thermal Resistance, R_{th} (Housing)	3.6 °C/W
Typical Thermal Capacitance, C_{th}	380 J/°C
Cont. Current to $\Delta T = 15^{\circ}C$	100 A
Cont. Current to $\Delta T = 40^{\circ}C$	164 A

PHYSICAL

Drawing

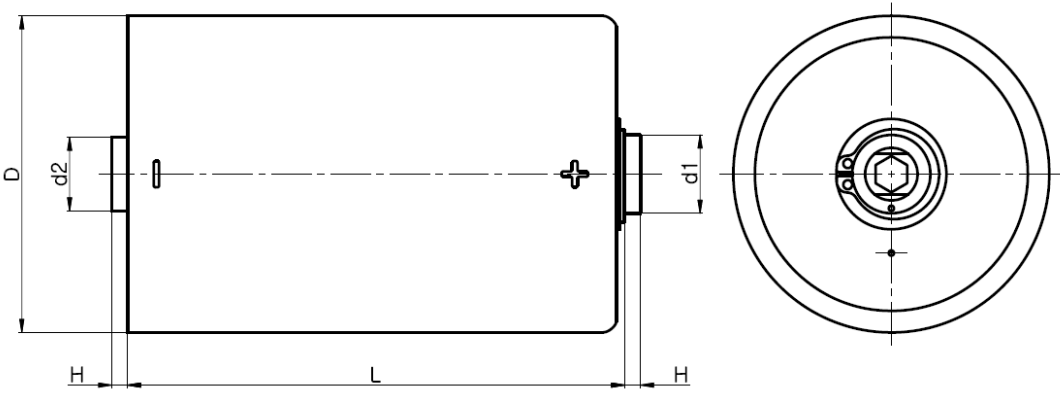

See Note on Mounting¹⁰

Dimensions	ESHSR-1600C0-002R7A5
D (± 0.2)	60.2 mm
L (± 0.3)	85.0 mm
H (± 0.125)	3.0 mm
d1 (-0.05)	14.9 mm
d2 (-0.05)	14.0 mm
Nominal Weight	335 g

Shock & Vibration	
Shock Specification	SAE J2464
Vibration Specification	ISO 16750-3 (Table 14)

NOTE

1. Surge Voltage

- > Absolute maximum voltage, not repeated and for no longer than 1 second.

2. Rated Capacitance

- > Constant current charge with 10mA/F to V_R
- > Constant voltage charge at V_R for 5min
- > Constant current discharge with 10mA/F to 0.1V

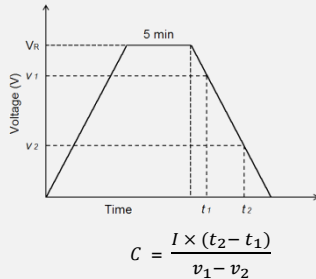

Where v_1 is the measurement starting voltage, $0.8 \times V_R$ (V);
 v_2 is the measurement end voltage, $0.4 \times V_R$ (V);
 t_1 is the time from discharge start to reach v_1 (s);
 t_2 is the time from discharge start to reach v_2 (s);
 I is the absolute value of the discharging current (A).

3. ESR (Equivalent Series Resistance)

- > ESR_{DC}
 - Constant current charge to V_R
 - Constant voltage charge at V_R for 5min
 - Constant current discharge to 0.1V

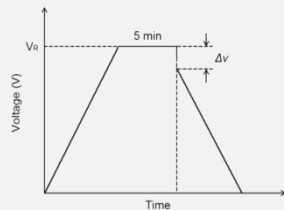

$$R_d = \frac{\Delta v}{I}$$

Where R_d is the ESR_{DC} (Ω);
 Δv is the voltage drop for 10ms (V);
 I is the discharge current (A).

4. Average (or Typical)

- > Percentage spread that may be present in one shipment

5. Leakage Current

- > The capacitor is charged to the rated voltage at 25°C.
- > Leakage current is the current at 72 hours that is required to keep the capacitor charged at the rated voltage

6. Max. Current

- > Current for 1sec discharging from rated voltage to half rated voltage under constant current discharging mode.

$$I_{Max.} (A) = \frac{\frac{1}{2}V_R}{\Delta t / C + R_d}$$

Where Δt is the discharge time (sec) and Δt is 1 sec in this case;
 C is the capacitance (F);
 R_d is the ESR_{DC} (Ω);
 V_R is the rated voltage (V).

- > Max. Current **should not** be used in normal operation and is only provided as a reference value.

7. Energy & Power

- > Max. Stored Energy at $V_R = \frac{\frac{1}{2}CV_R^2}{3600}$

Where C is the capacitance (F);
 V_R is the rated voltage (V).

- > Usable Specific Power, IEC 62391-2 (W/kg) = $\frac{0.12 \cdot V^2}{ESR_{DC} \cdot Mass}$

- > Impedance Match Specific Power (W/kg) = $\frac{0.25 \cdot V^2}{ESR_{DC} \cdot Mass}$

- > Gravimetric Specific Energy (Wh/kg) = $\frac{E_{Max.}}{Weight}$

8. Lifetime

- > End-of-Life Conditions
 - Capacitance: -30% from rated min. value
 - ESR: +100% from max. ESR value

9. Endurance

- > Conditions
 - Temperature: $65 \pm 2^\circ C$
 - Test duration : 1500 (+48/-0) h
 - Applied voltage: $V_R \pm 0.02V$
 - Capacitance and ESR measurement are made at 25°C

10. Mounting

- > Mounting should be designed in such a way as to not place undue mechanical stress on the terminals
- > Do not exceed the max torque value of 8Nm when assembling threaded type cells.
- > Provide adequate spacing in between cells to ensure required insulation strength for the application.
- > Provide clearance above the safety vent and do not position anything above the safety vent that may be damaged by vent rupture.
- > Welding recommendation for weldable cells available on www.nesscap.com under Support > Download.

The contents of this document are subject to change without notice. Values presented are thought to be accurate at the time of writing. Nesscap does not guarantee that the values are error-free, nor does Nesscap make any other representation, warranty or guarantee that the information is accurate, correct, reliable or current. For more information, you can reach us at one of following contacts

 Nesscap Energy Inc. Suite 3800, Royal Bank Plaza, South Tower, 200 Bay Street, P.O. Box 84, Toronto, Ontario, M5J 2Z4 CANADA	 Nesscap Energy Inc. S24040 Camino Del Avion #A118, Monarch Beach, California, 92629 USA	 Nesscap Co., Ltd. 17, Dongtangiheung-ro 681beon-gil, Giheung-gu, Yongin-si, Gyeonggi-do REPUBLIC OF KOREA	 Nesscap China Room 1608, Block N, Cangson Building, Chegonmiao, Futian District, Shenzhen City, P.R.C CHINA	 Nesscap Energy EASTERN EUROPE 10A, prospect 60-letiya Oktyabrya Moscow, 117036 RUSSIA	 Nesscap Energy GmbH Beerengarten 4 D-86938 Schondorf GERMANY
marketing@nesscap.com			info@nesscap-energy.de		